

EVO
//////93
SPECIAL EDITION

FULL HD 60
1080p FPS

USER MANUAL

SUMMARY

PREFACE	5
PRECAUTIONS.....	5
DESCRIPTION.....	5
TECHNICAL SPECIFICATIONS	6
STRUCTURE	8
EVO MM93 Structure	8
LED.....	8
OPERATING INSTRUCTIONS.....	9
Charge	9
Battery installation	9
TFT display installation.....	9
Inserting and removing the memory card	10
PRELIMINARY OPERATIONS.....	11
Date/time setting.....	11
Language	11
LEGENDA.....	12
LCD Symbols.....	12
Tft symbols	12
FRONT SELECTORS AND SETTINGS MENU	13
Exposure mode selector	13
G-SENSOR Selector	13
PARAMETERS SETTING.....	14
VIDEO PARAMETERS SETTING	14
Exe mode	14
Video resolution.....	15
View angle	15
Bitrate	16
Video content loop.....	16
180 photo rollover.....	16
Display time.....	17
CAMERA SETTING PARAMETERS.....	18
Capture mode.....	18

Photo resolution.....	19
Display time.....	19
SYSTEM PARAMETERS SETTING	20
Warning tone.....	20
Status indicator	20
On screen display.....	20
Auto to standby.....	21
TV output format.....	21
Language	21
Date/time	22
Format	22
recovery factory setting.....	22
STARTING STEPS.....	23
USING THE VIDEO CAMERA	23
Record a video, record a video without audio, record audio only	23
Recording a video in time lapse mode	24
Taking a picture	24
Photo shooting mode:.....	24
PLAYING A FILE (PLAYBACK)	24
Playing a video file	25
Viewing a photo file	25
Playing an audio file	26
Deleting, protecting and automatically playing a file	26
Deleting a file	26
Lock /Unlock file	26
OUTPUT INTERFACES	28
Hdmi video out.....	28
USB output	29
WI-FI CONNECTION	30
Android or iphone App	30
Connecting the phone and video camera.....	30
Application and functions	30
Video recording.....	31
Photo	31

Settings	32
File preview mode (Playback).....	33
Change Wi-Fi connection name and password.....	34
Change name and connection	34
Change password.....	34
TECHNICAL SPECIFICATIONS	35
PRECAUTIONS.....	36
Precautions for the camera case.....	36
Precautions for the 3M dual-side foam tape.....	36
WARRANTY AND LEGAL NOTES	37

PREFACE

Thanks for choosing EVO MM93, the high-definition digital camera.

Easy to use, compact and with an integrated design.

With its high-definition and dynamic image capturing technology it can record your daily activities at anytime and anywhere,

so you can remember your experiences and share them with your family and friends.

This manual will clearly explain you how to use and install the video camera, providing detailed information as well as technical specifications.

Please read this Manual carefully before the use and keep it for long-term reference.

PRECAUTIONS

Please observe the following points when using EVO MM93:

- Do not drop, hit or shake the camera.
- Keep the device away from any electromagnetic source, such as magnets or electro motors, or from any other object emitting strong radio waves, like antennas. Strong magnetic fields may cause failures to the camera or damages to image and audio.
- Do not expose the camera to high temperatures or to sunlight directly.
- Keep the memory card away from electromagnetic sources, such as TVs, speakers or magnets. Do not put it in any place with potential static, as the data stored may be lost.
- If the device overheats, smokes or smells in charging, please disconnect the power supply immediately.
- Keep the camera out of the reach of children in charging, as the power cord may cause accidental suffocation or electric shock.
- Keep the camera in a cool, dry and dust-free place.

DESCRIPTION

EVO MM93 is a compact, high-level and digital camera for professional use, able to perform the following functions:

- | High-definition (HD) digital photos.
- | Data-voice Storage function.
- | Real-time image display.
- | Recorded Video recall function.
- | Photo files recall function.
- | Time display.
- | Smartphone applications for Wi-Fi control.
- | 10X digital zoom.
- | External microphone connection for special use.
- | 2.0 USB High-Speed data transfer.
- | USB cable for battery charging.
- | All accessories are easy to use to facilitate shooting in any place and at any time.

Supplemented by its accessories, this product is the result of multiple patented technologies and can be used for recording anything, anytime, anywhere.

TECHNICAL SPECIFICATIONS

EVO MM93 camera has the following specifications:

- 170° ultra wide-angle lens f/2.7.
- HD lens, supporting 1080P, 960P, 720P video recording
- 16 mega pixel photo shooting function, supporting a maximum resolution of 4608x3456.
- Device Wi-Fi control via Smartphone applications (Apps).
- 10X digital zoom.
- Fast shot, for shooting up to 10 photos per second.
- Different shooting modes: single shot, continuous shot and self shot.
- Long-time voice recording function.
- Built-in vehicle black box for continuous real-time recording during driving.
- New generation Exmor R CMOS sensor with doubled sensitivity.
- 180° photo rollover function.
- Possibility of connection to an external screen for video viewing and photos playback.
- Better video effects in multiple video output modes:
 - 1920X1080P60 frames/second
 - 1920X1080P 48 frames/second
 - 1920X1080P 30 frames/second
 - 1920X1080P 24 frames/second
 - 1280x960P60 frames/second
 - 1280x960P 48 frames/second
 - 1280x720P 120 frames/second
 - 1280x720P 60 frames/second
- Battery level and free capacity of the memory card detection
- Supports micro SD up to 64GB capacity.
- Compact and fashionable design.
- Built-in stereo microphone and external microphone for high quality recordings.
- HDMI and AV output for an easy connection to a monitor or TV for the recall of recorded files.
- MP4 video files recording, ready to be recalled directly on PC or to be uploaded on video-sharing websites.
- High colour fidelity for clearer and more natural video images.
- Playback, file deleting and other functions on the local video camera.
- Fast video fast forwarding and rewinding when viewing.
- Internal G-sensor for automatic rotation function and black box for auto.
- The accessories will have reinforced structures for higher stability and durability.
- Chargeable high capacity lithium ion battery.
- Shock proof scratch resistant structure.
- With multiple types of accessories for sport recording.
- Shockproof features to withstand mild drops and knocks.

- Automatic standby for power saving and audio/video data saving.

STRUCTURE

EVO MM93 STRUCTURE

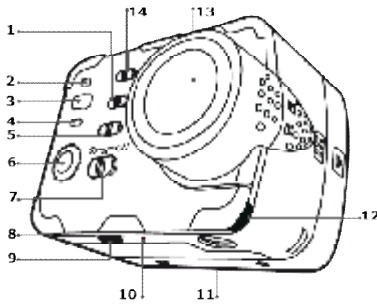

- | | |
|------------------------------|--|
| 1. Exposure meter | 8. Status led (available for future use) |
| 2. Blue Wi-Fi status led (a) | 9. Battery lock release |
| 3. Green status led | 10. Microphone |
| 4. Red status led (b) | 11. Threaded interface |
| 5. G-sensor | 12. Green status led (c) |
| 6. "Record" Key | 13. Lens unit |
| 7. Power Switch | |

- | | |
|---|-----------------------------|
| 1.Green status led (d) | 11.Photo and video view key |
| 2.LCD Display | 12.Menu Key |
| 3.Downward Key | 13.MicroSD Slot |
| 4.Upward Key | 14.USB interface |
| 5.OK Key | 15.Right Key |
| 6.Status led (available for future use) | 16.Mini HDMI Interface |
| 7.Status led (available for future use) | 17.Stop Key |
| 8.TFT display | 18.Shutter key |
| 9.Speaker | 19.Red status led (e) |
| 10.Left Key | 20.Microphone |

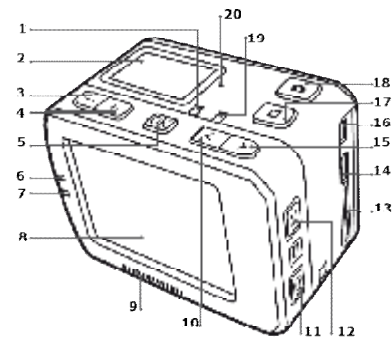

LED

	Position	Red Led	Green Led	Blue Led
		Front (b), Top (e)	Front (d) Top (e) Bottom (c)	Front (a)
Status				
Power		On		
Video recording			Slow flashing	
Audio recording			Slow flashing	
Shoot photo			Single flash	
Mem. full			On	
Charging (if off)		Slow flashing		
Charge (if off)		On		
Low battery level		5 sec. fast flashing, then off		
Data transmission				Slow flashing
WI-FI on				Slow flashing

OPERATING INSTRUCTIONS

CHARGE

Turn on the video camera and check battery status; if low, charge it.

Either a computer USB port or power adapter (not included) can be used to charge it.

When ECO is charged in off status, the red status led will flash slowly. When finished charging, the red led will remain on.

The charge process inhibits video camera operations.

BATTERY INSTALLATION

Before inserting the battery, make sure the lock/release button is open; fully insert the battery in the compartment and close using the lock/release button.



TFT DISPLAY INSTALLATION

EVO MM93 comes with a 2" removable TFT screen to view saved photos and videos.

Install the display as illustrated.

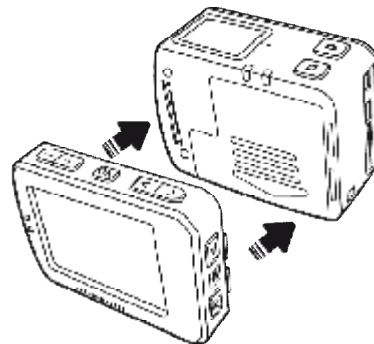

INSERTING AND REMOVING THE MEMORY CARD

The EVO MM93 video camera supports TF memory cards with capacity up to 64 GB.

Any type of Micro SD card can be used but we recommend high speed cards to optimise performance.

- Installation.

1 Make sure the video camera is off

2 Insert the card in its slot, being careful that it is inserted in the correct direction until a click is heard.

- Removal.

1 Turn off the video camera

2 Press the centre of the back of the card and release it; then remove it.

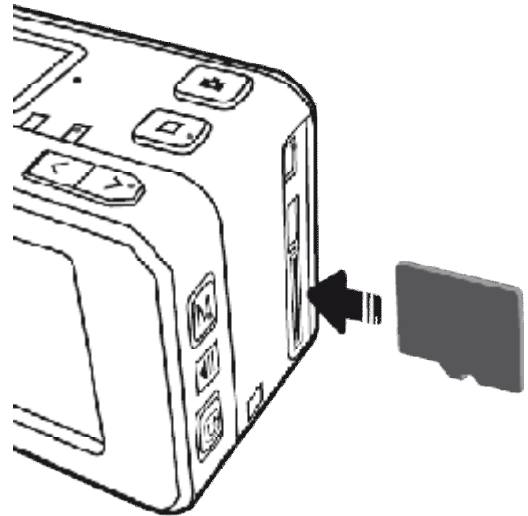

Before connecting the EVO MM93 to any Wi-Fi device, make sure the memory card is inserted.

PRELIMINARY OPERATIONS

Before using EVO MM93, set the date and time as well as the display language.

All EVO MM93 settings are accompanied by explicative graphic symbols.

The three small icons on the left of the screen represent:

-  A video camera: to select to edit video settings.

-  A camera: to select to edit photo settings.





-  A gear: to select to edit common settings.

The icon is outlined in blue when the option is selected.

DATE/TIME SETTING

It allows to adjust the date and the time

1. Key 



2. Press   and  key to scroll the setting menu up to 

3. Press   and  to reach the item 

4. Press to confirm the selection 

5. Select one of the available formats:

- Y-M-D-H-M (year, month, day, hour, minutes)
- D-M-Y-H-M (day, month, year, hour, minutes)
- M-D-Y-H-M (month, day, year, hour, minutes)



6. Modify the values and move from an item to another with the following keys   and 

7. Press  key to confirm

LANGUAGE

Lets you select the standard language.

1. Key 

2. Press   key to scroll the setting menu up to 

3. Press   and  to reach the item 

4. Press to confirm the selection 





5. The choices available are:

- English, Italian, Portuguese, Spanish, French, German, Greek, Korean

LEGENDA







Following are the symbols that most commonly appear on the screen.

LCD SYMBOLS

	Video recording mode	Displayed in the upper left corner, it indicates the video recording mode
	Photo camera mode	Displayed at the top left when EVO MM93 is in photo camera mode
00:00:22	Video recording duration	Displayed in the centre position, it indicates the duration of the current recording video. The time is synchronously displayed with the one on the TFT screen.
100-102	Number of remaining photos	Displayed at the centre, in alternative to the video recording length. Indicates the number of photos taken
	Battery capacity indication	Displayed on the bottom right, it indicates the battery level.
	USB connection mode	Displayed at the centre, it indicates whether the camera has been connected to a PC. EVO MM93 is charging and is connected to transfer files to the PC.
2H:17	Residual capacity	Displayed in small letters at the bottom left, it indicates the memory available space for videos.
5307	Residual capacity	Displayed in small letters at the bottom left, it indicates the memory available space for pictures

A series of symbols are also displayed on the TFT screen at the same time; some similar to those already seen, others more specific.

TFT SYMBOLS

	Video recording mode	Displayed in the upper left corner, it indicates the video recording mode
	Audio recording mode	Displayed in the whole TFT display during the audio registration
	Photo camera mode	Displayed at the top left with the shutter key is pressed once
	Power symbol	Displayed in the upper right corner, it indicates the battery level
1080P/30	Video/Photo resolution	Displayed in the bottom left corner, it indicates the resolution active in that moment. If in photo mode, it displays resolution in mega pixels
	Wi-Fi	Displayed at the top left, it indicates Wi-Fi connection on the video camera
	Exposure meter	Displayed at the top centre, it indicates that exposure meter SPOT mode is on
	G-SENSOR	Displayed at the top left, it indicates that automatic movement detection is on

FRONT SELECTORS AND SETTINGS MENU

Some selectors are located on the front of the video camera

EXPOSURE MODE SELECTOR

According to need and lighting conditions, the video camera exposure meter can be set to SPOT mode.

This mode is used to adjust the amount of light according to a well-defined central point.

Two different exposure meter management modes are included:

Central Area: set this parameter in order to improve the central dark area, if the central area is dark but the surrounding area is bright.

Spot: on the contrary, if the central area is bright and the surrounding area is dark, use this setting in order to improve the image in the outer darker area.

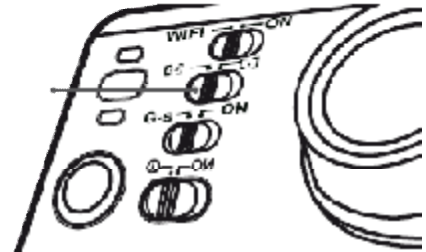

G-SENSOR SELECTOR

Turn on the G-SENSOR for the video camera to automatically detect any change in gravity.

This function is especially helpful for installations on vehicles or when installed on a helmet and thus hard for the user to reach.

Any video camera movement will automatically turn it on. Recording stops when no movement is detected for 3 minutes.

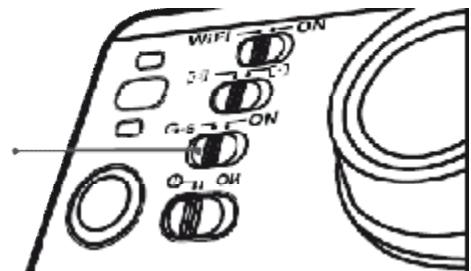

PARAMETERS SETTING

To set video camera parameters, use key  and navigate the menu with keys   and , then confirm selections by pressing key .

VIDEO PARAMETERS SETTING







Symbol to select on the left side of the screen



EXE MODE

Icon 

It allows to select the using mode of EVO MM93 video camera.

1.  key
 2. **EXE' selected by default**
 3. Press  to confirm
 4. Press   and  key to modify the choice, press  key to confirm.
- Please choose one of the following options:

- Video 
- Video without audio 
- Audio 
- Time Lapse 

Possible intervals in seconds are:0.5, 1, 2, 5, 10, 30 off

The resulting video will be a more or less accelerated video depending on the setting parameter used.

A normal video has a reproduction of 30 or 60 frames per second.

For example, if you set the parameter at 2 seconds, the result is 30 frames in one recording minute.

Supposing to display it at 30 frames per second, the final resulting video will last one second; a one-hour video will last about 60 seconds in play mode.

Obviously during this mode the photo camera must be fixed on a tripod or leant on a support.









Note: this function is mostly used to display long events in quick sequence (blossoming flower, rising sun, moving clouds, etc.)

- Video start delay timer 

Possible choices in seconds are:0.5, 1, 2, 5, 10, 30 off

VIDEO RESOLUTION









It allows to select the desired resolution for the video recording.

1.  key
 2. Press   and   to reach the item 
 3. Press  key to confirm
 4. Choose the desired item and press  key to confirm
- The choices for the video resolution are the following:

1080P (16:9)	960P (4:3)	720P (16:9)
1920X1080	1280X960	1280X720
60 fps	60 fps	120 fps
48 fps	48 fps	60 fps
30 fps		
24 fps		

VIEW ANGLE









It allows to set 4 types of views with different angles.

1.  key
 2. Press   and   to reach the  item
 3. Press  key to confirm
 4. Choose the desired item and press  key to confirm
- The view available choices are:
- wide (W), medium (M), narrow (N), small (S)

This function is available for HD video recording in 1080P or 1080i photo mode only

BITRATE

It allows to change the numbers of recorded frames per each recording second.

1.  key
2. Press   and   to reach the  item
3. Press  key to confirm
4. Choose the desired item and press  key to confirm

The bit rate choices available are:









- normal (N), high (F).

The higher the parameter is, the clearer is the image, but the file size increases.

VIDEO CONTENT LOOP

Lets you start or stop the loop recording function.

If on, the video file will be automatically saved in 15-minute segments; If off, the video file will be saved in 30-minute segments.

1.  key
2. Press   and   to reach the  item
3. Press  key to confirm
4. Choose the desired item and press  to confirm









The bit rate choices available are:

- On, Off.

This function is not available with 1080P 50f/60f, 720P 100f/120f video resolution

180 PHOTO ROLLOVER









This function rotates the display and camera menu 180°

1.  key
2. Press   and   to reach the  item
3. Press  key to confirm
4. Choose the desired item and press  key to confirm

This function is not available with 1080P 50f/60f, 720P 100f/120f video resolution

DISPLAY TIME

This function records automatically the date and time during the video recording and displays them in a video in the bottom right corner of the screen.

1.  key
2. Press   and   to reach the  item
3. Press  key to confirm
4. Choose the desired item and press  key to confirm









This function is not available with 1080P 50f/60f, 720P 100f/120f video resolution

CAMERA SETTING PARAMETERS



 Symbol to select on the left side of the screen

CAPTURE MODE

Lets you set photo shooting mode.

1.  key
2. Press   and   to reach the  item
3. Press  key to confirm
4. Choose the desired item and press  key to confirm

The choices are:

- Single shot 
- Multiple shot 
The choices available are: 3, 6, 10 shots per second.
- Self timer 
The choices available are: 3, 5, 10-second delay.









Press the  Photo key to start the reverse counting timer. The self timer indicator blinks and the camera takes a picture.

To disable the self timer function proceed as above explained and select OFF; on the contrary the self timer is maintained.

This function is not available with 1080P 50f/60f, 720P 100f/120f video resolution.

PHOTO RESOLUTION

It allows to select the resolution photo resolution.









1.  key
2. Press   and   to reach the  item
3. Press  key to confirm
4. Choose the desired item and press  key to confirm

Possible resolutions are:

16.0M (4608×3456 4:3), 12.0M (4000×3000 4:3), 8.0M (3200×2400 4:3).

DISPLAY TIME

This function automatically records the date and displays the photo at the bottom right.

1.  key
2. Press   and   to reach the  icon
3. Press  key to confirm
4. Choose the desired item and press  key to confirm

This function is not available with 1080P 50f/60f, 720P 100f/120f video resolution









SYSTEM PARAMETERS SETTING



Symbol to select on the left side of the screen









WARNING TONE

Set this function to enable the tick tone









1.  key
2. Press   and   to reach the  item
3. Press  key to confirm
4. Choose the desired item and press  key to confirm
The choices available are: Off, 50%, 100%.

STATUS INDICATOR

It allows you to turn off the frontal status led









1.  key
2. Press   and   to reach the  item
3. Press  key to confirm
4. Choose the desired item and press  key to confirm
The choices available are:
 - On, 2 (only 1 frontal led and 1 top led on), Off.

ON SCREEN DISPLAY

1.  key
2. Press   and   to reach the  item
3. Press  key to confirm
4. Choose the desired item and press  key to confirm
The choices available are:
 - On, Off.

AUTO TO STANDBY

It allows the automatic turn-off of the video camera display.

1.  key
2. Press   and   to reach the  item
3. Press  key to confirm
4. Choose the desired item and press  key to confirm

The choices in minutes are:

- 10,5,2,Off.









Where there is no operation, the system starts counting the time.

When the preset time is reached, the video camera enters the standby mode.

In case that any operation is carried out in the meanwhile, the system restarts counting the time.

TV OUTPUT FORMAT

It sets the output format for a TV connection.

1.  key
2. Press   and   to reach the  item
3. Press  key to confirm
4. Choose the desired item and press  key to confirm

The choices available are:

- Ntsc, Pal.













LANGUAGE

Lets you select the standard language.

1.  key
2. Press   and   to reach the  icon
3. Press to confirm the selection 
4. Select one of the available formats:
 - English, Italian, Portuguese, Spanish, French, German, Greek, Korean

DATE/TIME

It allows to adjust the date and the time









1.  key
2. Press   and   to reach the  item
3. Press to confirm the selection 
4. The choices available are:
 - Y-M-D-H-M (year, month, day, hour, minutes)
 - D-M-Y-H-M (day, month, year, hour, minutes)
 - M-D-Y-H-M (month, day, year, hour, minutes)
5. Modify the value and press   and   key to move from an item to another
6. Press  key to confirm

FORMAT

It allows to format an external memory card

1.  key
2. Press   and   to reach the item 
3. Press to confirm the selection 
4. Choose the desired item, press  key to confirm and confirm again at any request.

RECOVERY FACTORY SETTING

1.  key
2. Press   and   to reach the  icon
3. Press  key to confirm
4. Choose the desired item and press  key to confirm

ATTENTION! This action restores the standard settings in English

STARTING STEPS

Before using your EVO MM93:



- Make sure that the battery is full. If the level is low, connect the video camera to a computer using the supplied USB cable to charge the battery. The mini red led slowly flashes when charging. When battery is fully charged the red indicator stays on and the battery icon  will appear from the TFT screen
- Format the micro SD memory card (as described in System Parameters Setting paragraph)
- Set data and time (as described in System Parameters Setting paragraph)

Now you can proceed with all other parameters settings of your EVO MM93 according to your needs.

USING THE VIDEO CAMERA

The parameters can be modified as described above in the relevant chapters.

Before using your EVO MM93, make sure it is set according to your needs.

Press keys  and  in sequence to switch the video camera from video modes (with video only, audio and video, audio only options) to photo mode.

RECORD A VIDEO, RECORD A VIDEO WITHOUT AUDIO, RECORD AUDIO ONLY

See the relevant paragraph for EVO MM93 settings (Video settings).

In the preview state press the Record  key on the front of the camera to start video recording.

The video recording duration is displayed in the upper right part of the TFT screen.

The small green led on the top, the one on the lower right and the one on the front of the video camera will flash slowly.

The recording duration is displayed both on the LCD display and on the TFT screen.

When recording, the video camera only responds to the zoom out and zoom in keys  .

Press the Stop  key once to stop and save the video file you are recording.

The Video camera restores to the preview state and the recording duration disappears from the LCD segment screen.

NOTE: Turn the power switch to OFF only after having saved the currently recorded file.

If the battery power runs low during the video recording, the system saves the currently recorded file and enters standby mode, displaying a prompt of "Low Battery" on the TFT screen, until the video camera is powered off.

If the Micro SD card is full during the video recording, the system saves the currently recorded file and the system displays a message "Card full" on the TFT screen. The duration for video recording stops on the LCD segment screen and the system restores to the preview state.

In cyclic recording mode, the system automatically saves a file every 15 minutes. (The

cyclic recording function and the pre-video function cannot be simultaneously enabled)



RECORDING A VIDEO IN TIME LAPSE MODE

In the preview state press the Record  key, on the front of the camera, to start video recording without audio.

The video recording duration is displayed in the upper right part of the TFT screen.

The small green led on the top, the one on the lower right and the one on the front of the video camera will flash slowly.

The recording duration is displayed both on the LCD display and on the TFT screen.

When recording, the video camera only responds to the zoom out and zoom in keys  .

Press the Stop  key once to stop and save the video file you are recording.

The Video camera restores to the preview state and the recording duration disappears from the LCD segment screen.

Note: Time Lapse mode requires the following values: 0.5, 1, 2, 5, 10, 30s. This indicates that a video is made with photograms shot in sequence in the set time interval.

TAKING A PICTURE

Press the  key once to switch EVO MM93 to photo mode.

Before taking a picture some parameters must be set according to the situation.

The parameters can be modified as described in paragraph:

CAMERA PARAMETERS SETTING

Here below a quick sum up:

Photo shooting mode:

- Single shot (default mode)

In the preview state press the  key to take a picture while the system generates a click tone. The green indicator on the front side of the video camera blinks once (the shooting icon on the LCD screen blinks once too) and the video camera restores to the preview state.

- Fast shot

It is possible to choose 3 p/s or 6p/s or 10 p/s (pictures/second).

By pressing the  key once, EVO MM93 video camera will shot 3, 6, or 10 images per second.

- Auto shooting



It is possible to choose 3, 5, 10 seconds.

The reverse-counting timer starts after pressing the  key once.

PLAYING A FILE (PLAYBACK)

You can view what you recorded (photos, video, audio, etc.) on your EVO MM93.



To view a file, proceed as follows:







1.  key
2. Three icons appear on the right side of the screen.
3. Press the  key in sequence to enable view mode:
Video only, photo only, video and photo.



PLAYING A VIDEO FILE

Display all thumbnails, select the desired file and press  to play it.







When playing a video file, you can use the following keys:   and .

Key	Description
 	Turns the sound volume up and down during playback.
	Enlarges or shrinks the picture preview, but not during playback.
	Press this key to fast forward or fast rewind. By keeping the key pressed for more than 3 seconds, you start the SLOW-MOTION function that allows you to view the video files with ¼ reduced speed.
	Returns to the playback interface when you press this key again.
	Starts or suspends playing a video file when you press this key.

VIEWING A PHOTO FILE

Display all thumbnails, select the desired file and press  to play it.

The following functions are available once you've viewed the picture:



Key	Description
	Zoom a picture in or out. In zoom-in mode, it locks a picture and moves it upwards or downwards when you press  .
 	In zoom mode, it moves the picture leftwards or rightwards.
	Returns to the playback interface when you press this key again.
	In zoom in mode, switches between the moving and zooming mode.

PLAYING AN AUDIO FILE

A group of video files are displayed with the audio file in preview status; the  icon will be displayed instead of the initial video icon.

Press  to play the audio file

You can use the following keys:

Key	Description
	Turns the sound volume up and down
	Returns to the playback interface when you press this key again.
	Starts or suspends playing an audio file











During the playback mode of an audio file all other keys are disabled.

DELETING, PROTECTING AND AUTOMATICALLY PLAYING A FILE

In playback mode, you can delete, protect and automatically play a file.

Deleting a file

On the video, photo interface or video & photo interface, you can delete the corresponding files. To delete a file, perform the following operations:

1.  key to switch to photo view mode
2. Press keys   and  to move to the file to be deleted
- 3 Press  to select it
4. Press , select the  icon and press  to confirm
5. Select the desired item from:
 - Delete single 
 - Delete all 
6. Choose the desired item, press  key to confirm and press again at any request













The option acts according to the displaying mode. In case of more image files and only one video file, in video and photo displaying mode, the choice "delete all" will be available, on the contrary in video displaying mode only "delete single" will be available.

It is possible to delete the not previously protected files only.

Lock /Unlock file

A protection flag can be added to a video or file from the video, photo or video and photo interface to prevent them from being accidentally deleted.

To protect a file, perform the following operations:

1.  key to switch to photo view mode
2. Press keys   and   to move to the file to be protected
3. Press , select the  icon and press  to confirm
4. Select the desired item from:
 - Protect single 
 - Protect all 
 - Remove protection from single 
 - Remove protection from all 

No confirmation is required; the protected files are displayed with icon .

Vice versa, unprotected files are displayed with icon .

Protected files cannot be deleted with the delete function. In any case, formatting a memory card deletes all data.

OUTPUT INTERFACES

EVO MM93 Photo camera has 1 audio video output interfaces:

- Hdmi

and one data files output:

- Usb

HDMI VIDEO OUT

You can connect the photo camera to a video input, through the Hdmi output, by using a specific cable (not supplied).

In the meanwhile the video camera can work normally.

The display or the TV, connected to the video camera, works exactly like the TFT display of the video camera.

In this way you can see photos or videos in playback mode, or adjust the setting parameters.

Incorrect HDMI cable removal could cause EVO MM93 video camera malfunctions. After rebooting, the EVO MM93 video camera returns to normal conditions. This function is not available when the Wi-Fi device is on

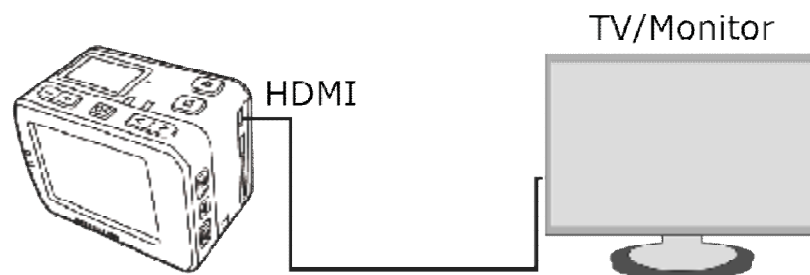

USB OUTPUT

The USB connection allows to :

- Give power supply to the EVO MM93 video camera with a USB cable
- Connect the EVO MM93 video camera to a computer in order to read the data in its memory and micro SD card.

The icon of USB connection is displayed on the LCD screen and the green indicator blinks slowly.

Incorrect USB cable removal could cause EVO MM93 video camera malfunctions. After rebooting, the EVO MM93 video camera returns to normal conditions.

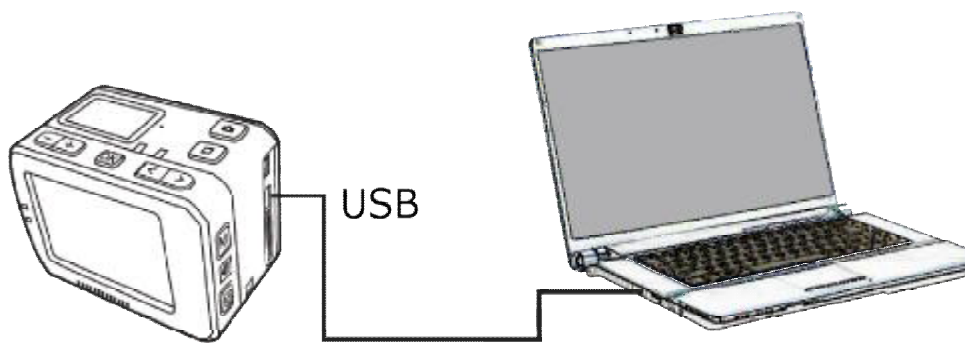

WI-FI CONNECTION

Thanks to the built-in Wi-Fi module, EVO MM93 can be connected to Apple or Android Smartphones and Tablets and remotely controlled.

Just download the free NILOX F-60 EVO MM93 App to connect the device in Wi-Fi.

ANDROID OR IPHONE APP

Open the App-Store or Google-Play Store, search for the NILOX F-60 EVO MM93 App and download it; the icon will be displayed



CONNECTING THE PHONE AND VIDEO CAMERA

- Switch the Wi-Fi selector on the front of the video camera ON; the blue status led will start to flash and the Wi-Fi signal icon  is displayed at the top left corner of the TFT screen.
- Wait until the blue led starts to flash slowly.
- At this point, look for new available Wi-Fi connections on your phone.
- Select F-60 EVO MM93, the default password is *Nilox1234*
- At this point, start the App you previously downloaded on your phone.

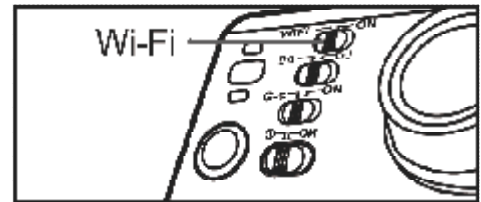

APPLICATION AND FUNCTIONS

Once your EVO-MM93 and Smartphone are connected, start the application that will appear in the following screen:

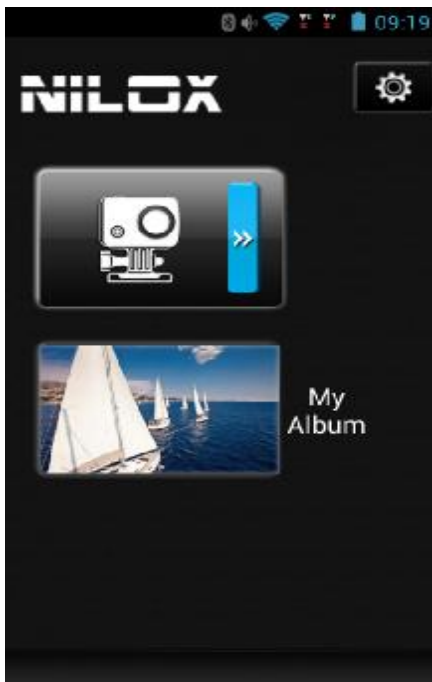

The first icon opens EVO-MM93 functions, the second lets you view recorded videos and photos.

Video recording



To start recording, press the central green key.

Icon meanings are highly self-explanatory, starting from the top left in clockwise order:

- 1) Wi-Fi on
- 2) Battery level
- 3) Exit screen
- 4) Settings
- 5) Video mode on
- 6) Recording
- 7) Switch to view mode
- 8) Set video settings

The mobile device must be used within max. 100 metres from the video camera and without obstacles.

Real-time preview is not available for 1080p 48fps/50fps/60fps e 720P 100fps/120fps video recording.

Photo

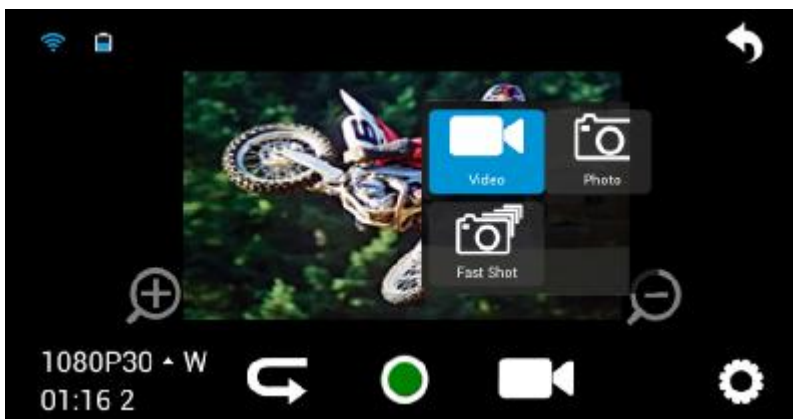

Touch the icon  to switch from video mode to photo mode and select between single photo and burst mode.



In this case too, the icons are highly self-explanatory and similar to those already seen for videos.

Settings

Click on the gear at the bottom right to open the cam settings menu.

Most parameters can be set and some operations run from this menu for correct cam operations.

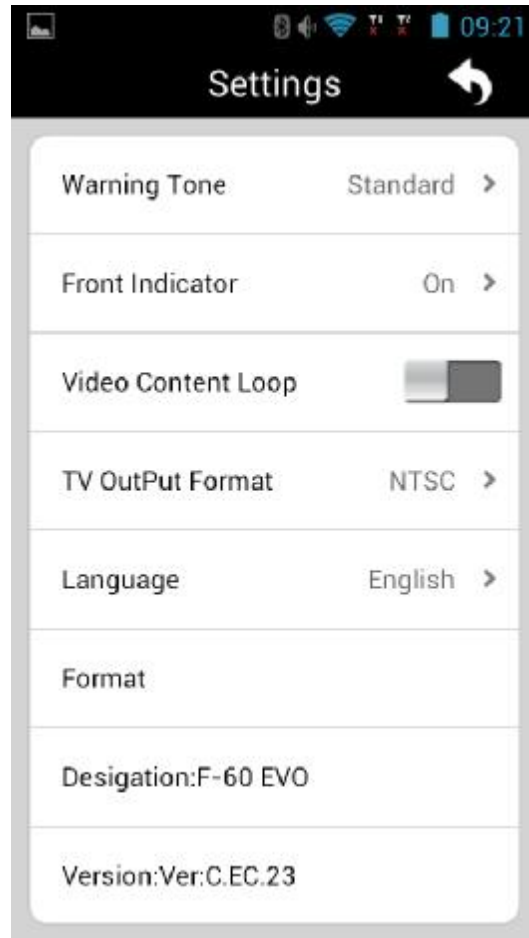
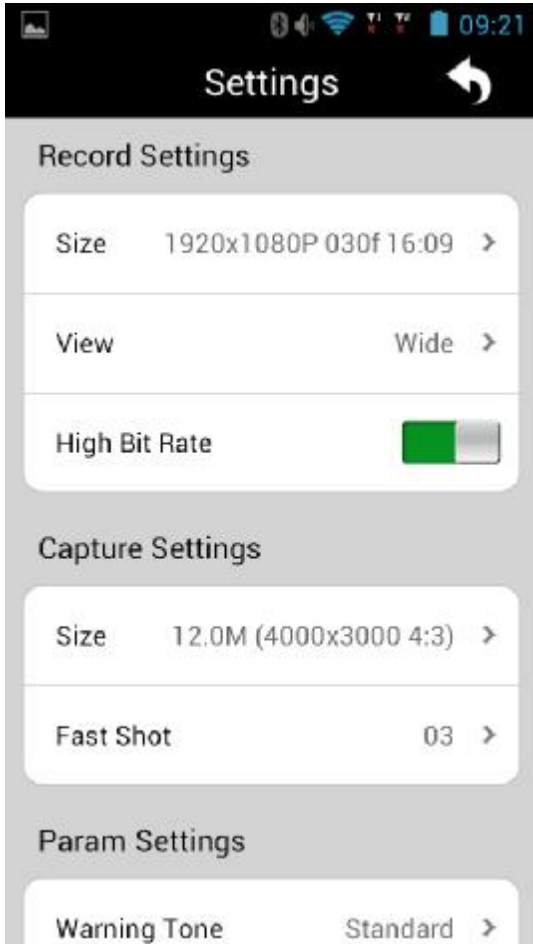

File preview mode (Playback)

From the main menu, press  to open the file preview menu.

Alternatively, the same menu can be opened from the home screen by selecting My Album.

If the selector is positioned on cam (left) the user can either view a photo or video or download it to smartphone or tablet.

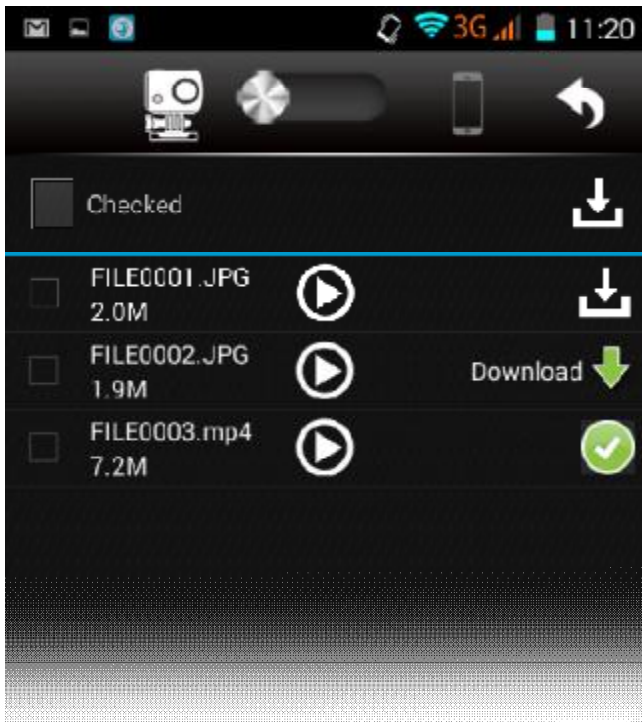

The image is immediately displayed when preview is selected.



Move the selector to the right to smartphone device to open the downloaded photo and video gallery.

Touch the icon depicting the photo album



opens the photo and video gallery

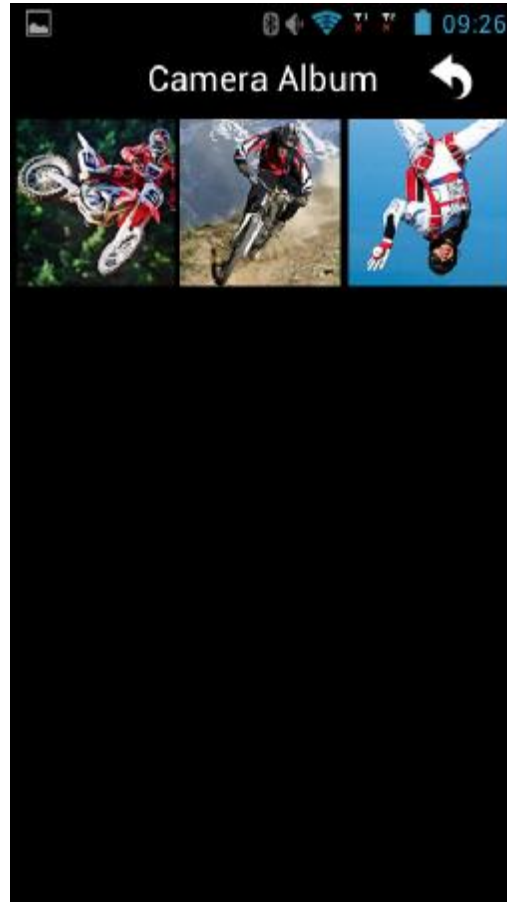

For best recorded photo and video viewing, we recommend using the player specific to the tablet or smartphone used.

CHANGE WI-FI CONNECTION NAME AND PASSWORD

Change name and connection

- Connect the photo camera (with MicroSD card inserted) to the computer and turn on the photo camera.
- Open "My computer" and find the virtual drive associated with the EVO MM93 video camera.
- Open file "WiFi.conf" in folder "MISC" and search for the string "AP_ SSID = *F-60 EVO MM93*".
- Change the content after the "=" symbol.
- Save the file.

Change password

- Connect the photo camera (with MicroSD card inserted) to the computer and turn on the photo camera.
- Open "My computer" and find the virtual drive associated with the EVO MM93 video camera.
- Open file "WiFi.conf" in folder "MISC" and search for the string "AP_ PASSWD = *Nilox1234*".
- Change the content after the "=" symbol.
- Save the file.

TECHNICAL SPECIFICATIONS

Wide angle	170°
Shutter opening	f/2.7
Digital zoom	10X
Pixel	16 million
Video recording format	MP4
Audio recording format	WAV
Photo format	JPG (JPEG)
Wi-Fi coverage	about 100 metres (Max.)
Memory device	128 MB internal memory up to 64 GB on external Micro SD card
Battery capacity	1500mAh
Charge time	With USB cable, about 4 hours, with charger, about 2.5 hours
Maximum video recording time	About 2 hours (Max.)
Maximum audio recording time	About 3 hours (Max.)
TFT Display	2.0" true color TFT display (16:9)
LED	Dot-matrix screen 90×64mm FSTN
Supported Operating System:	Windows XP SP2 /Vista or above / Mac OS
Storage temperature	-20°C ~ 60°C
Working temperature	-10°C ~ 50°C
Dimensions	L59 × W43 × H47MM (TFT display) L59 × W43 × H35MM (no display)
Weight	116g (with TFT screen and battery),56 g(without screen and battery)

PRECAUTIONS

PRECAUTIONS FOR THE CAMERA CASE

The waterproof case is a precision component. Please use the following precautions:

- Do not randomly dismount and mount the O-ring of the case, keys and lens cover, otherwise the waterproof performance deteriorates.
- Do not put the case in a place where corrosive gases are easily generated due to the existence of strong acid or alkali and keep it away from chemical or corrosive substances.
- Do not store the product in a place where temperature is too high (over 50°C) or low (-10°C) for a long time to avoid deformation.
- Do not expose it to direct sunlight for a long time to avoid deterioration of the waterproof performance.
- Before the use, ensure that the O-ring is intact, the seal is litter-free, the case is fully sealed and the buckle is tight.
- After use in salt water, immediately rinse the case under running water.
- Use a dry cloth to dry the surface and store the device in a dry and ventilated place.

PRECAUTIONS FOR THE 3M DUAL-SIDE FOAM TAPE

When using the 3M dual-side foam tape, adhere to the following precautions:

- Before fixing the 3M dual-side foam tape, select a proper surface to ensure proper contact between the foam tape and the surface.
- Before using the 3M dual-side foam tape, clean the surface and heat the foam tape, using for instance an electric blower, especially in a place where temperature is lower than 0°C.

Before using EVO MM93 video camera, pay attention to the following notice information:

- During continuous use, the body temperature of EVO MM93 video camera increases. The situation is normal. The camera surface may be hot after prolonged use.
- If the video camera is not used for a long time, remove and keep the battery properly and recharge it every three months to ensure the battery performance.
- During recording, the digital zoom may affect the image quality.
- Shooting view angles are slightly different in different working modes of the video camera.
- If a video file is large in size, a computer or other professional players are preferred for a smooth playback.
- Cyclic recording and frequent recording/deleting operations may leave data fragments in the SD card, causing failure to file recording or saving. To solve this problem, just backup the data on an external storage and format the SD card.

WARRANTY AND LEGAL NOTES

EVO MM93 is equipped with a rechargeable lithium polymer battery. To reduce the risk of fire, please avoid tampering, falls, contact with water or fire.

To avoid personal injury, electric shock, fire or damage to various parts of the product, please follow the following instructions: **Do not immerse the product without its waterproof case into water**

Personal Safety.

Do not disassemble, repair, alter or modify any part of the O-ring of the product. Do not touch the product with metallic objects or chemicals.

Any failure to comply with what above can cause risks to the person and other people.

In case of malfunctioning of the product, please contact the technical service or a qualified supplier.

Technical support.

This product is warranted in accordance with current legislation and therefore please contact your dealer in case of need of technical assistance and / or warranty service.

Instructions for the environment:



This product may contain substances that can be harmful to the environment and to the human health, if not disposed of properly.

We therefore provide you the following information in order to prevent the release of such substances and to improve the use of natural resources.

The electrical and electronic products should not be disposed of in the normal household waste, but should be properly collected in order to be correctly treated.

The symbol of the crossed bin shown on the product and in this page reminds the need to properly dispose of the product at the end of its life.

In this way you can avoid that a non-specific treatment of the substances contained in these products, or an improper use of parts of them can lead to harmful consequences for the environment and human health.

Moreover, you can contribute to the recovery, recycling and reuse of many of the materials composing these products. That is why the manufacturers and distributors of electrical and electronic systems organize the proper collection and disposal of the equipment themselves.

At the end of the product life please contact your dealer for instructions regarding the collection.

When purchasing this product your distributor will inform you of the possibility to replace your old device with a new one, on condition that the type of product and its functions are the same.

Any disposal of the product different from what described above will be liable to the penalties foreseen by the laws in force in the country where the product is disposed of.

Moreover we suggest to adopt additional measures favourable to the environment: recycling the inner and outer packaging and properly dispose of used batteries (if any).

With your help we can reduce the amount of natural resources used for the realization of electrical and electronic equipment, minimizing the use of landfills for the disposal of products and improving the quality of life by preventing to release into the environment potentially dangerous substances.

Installing and replacing batteries



The product contains a battery that could be replaced during the lifetime of the product itself.

At the end of life of the batteries contained in the product, they must be disposed of separately.

Throw them in the appropriate containers for the disposal of batteries.

The collection and recycling of batteries contribute to the protection of the environment and to the preservation of material resources, allowing the recovery of valuable materials too.

Declaration of Conformity

Product complies with 1999/5/CE-2011/65/CE Directive. The declaration in full version and the technical documentations are available at our headquarters - Hellatron S.p.A Via E. Mattei 10 20010 Pogliano M.se (MI).

Keep the packaging for future references.

Warranty information

- One year, if invoiced to a company or professional (with VAT number).
- Two years, if fiscally described as sold to a private citizen.
- This warranty is referred to in the event a conformity defect occurs, referred to product features.
- Product support and warranty. Visit www.nilox.com to learn more.

Warranty restrictions: this warranty does not apply in the following cases:

- no proof of purchase (invoice or receipt).
- tampering, forcing and damages on the hardware and screen, created for any reason.
- other defects to to: inappropriate use, unauthorised hardware/software changes, operations or storage beyond technical product specifications; incorrect maintenance; defects due to the use of software other than that supplied and all those elements (hardware and software) not designed to be used with the product.

The above refers to legislative decree dated February 2, 2002. Implementing the 1999/44/CE Directive.



Brief Declaration of Conformity

This device was tested and meets European Parliament and European Commission Directive 2011/65/EC and 1999/5/EC concerning radio equipment and peripheral devices for



telecommunications and their mutual recognition. The declaration of conformity is available at our offices.

This device can thus be used in all EEC countries and in all countries where Directive 1999/5/EC applies, without restrictions, except for:

Norway (NO): device not to be used within 20 km of Ny Alesund.

Italy (IT): This peripheral complies with the National Radio Interface and meets requirements on Frequency Assignment. The use of this device beyond the areas where the owner works requires general authorisation. For further information please visit: www.comunicazioni.it.



CE () logo and/or WEEE () logo, in some devices, isn't fully compliant with minimum dimensions requirement to European Directive due to limited sticker area