

Master Anamorphic 50/T1.9

A range of seven high-performance prime lenses, the ARRI/ZEISS Master Anamorphic series represents a significant step forward in the technology and practicality of anamorphic cinematography for 35 format digital and film cameras.

For the first time, a perfect combination of compact size, minimal weight, very high speed and exceptional optical design with minimal distortion has been achieved in a set of anamorphics. With beautiful out-of-focus backgrounds and a smooth, cinematic look, the Master Anamorphic lenses are as fast and easy to use on set as other modern cine lenses.

Main Features

- Low distortion for uncompromised Cinemascope
 - straight lines stay straight
 - no distortion compensation in post necessary
 - low distortion even at close focus
- Cinematic bokeh with high contrast and nice focus fall-off
 - very smooth out-of-focus image
 - immersive look
- Beautiful skin tones and precise color rendition
 - smooth and pleasant skin tones
 - Crisp, natural color rendition
- Characteristic out-of-focus highlights
 - oval and uniformly illuminated out-of-focus highlights
 - smooth iris shape because of 15 aperture blades
- Large image field for full freedom in composition
 - full 2.39:1 format is useable for image composition
 - no visible image drop at the corners
- Large aperture of T1.9 for shallow depth of focus
 - T1.9 useable with any focal length at any distance
 - overcomes the old rule: "anamorphics need to be stopped down to T4.5"
- Virtually no image breathing
- No anamorphic mumps (fat face effect)
- Super color matched to other ARRI/ZEISS primes and ARRI/FUJINON zooms
- ARRI Lens Data System (LDS) for lens metadata

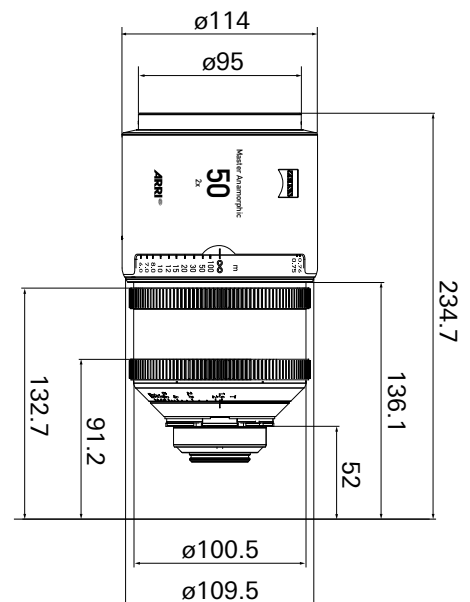

Technical Details

Lens Mount ⁽¹⁾ :	PL-LDS
Aperture	T1.9 - T22
Close Focus ⁽²⁾	0.75 m / 2'6"
Magnification Ratio ⁽³⁾	H: 1:22.2, V: 1:11.1
Length ⁽⁴⁾	183 mm / 7.2"
Length including flange focal distance ⁽⁵⁾	235 mm / 9.3"
Front Diameter ⁽⁶⁾	95 mm / 3.7"
Maximum Housing Diameter	114 mm / 4.5"
Weight (kg)	2.6
Weight (lbs)	5.7
Entrance Pupil ⁽⁷⁾ (mm)	-171
Entrance Pupil ⁽⁷⁾ (inch)	-6.75
Angle of View H - V	48° - 21°
Super 35 Cinemascope ⁽⁸⁾	
Image Diameter	29.26 mm ⁽⁹⁾

^(x) For abbreviations please see legend at end of document

ARRI Lenses Technical Legend

⁽¹⁾ **Lens Mount**

Positive locking (PL) 54 mm stainless steel lens mount with Lens Data System (LDS) contacts.

⁽²⁾ **Close Focus**

Close focus is measured from the film/sensor plane.

⁽³⁾ **Magnification ratio**

Magnification Ratio is the relationship of the size of an object on the film/sensor plane (first number) to the size of that object in real life (second number) at the close focus setting; horizontal (H) and vertical (V).

⁽⁴⁾ **Length**

Length is measured from the lens mount to the front of the lens housing.

⁽⁵⁾ **Length including flange focal distance**

Length is measured from the image to the front of the lens housing.

⁽⁶⁾ **Front Diameter**

Diameter of the lens/matte box interface.

⁽⁷⁾ **Entrance Pupil**

The distance from the entrance pupil to the film/sensor plane at focus = infinity. Positive numbers indicated an entrance pupil behind, negative numbers indicated an entrance pupil in front the film/sensor plane.

The entrance pupil (often mistakenly called "nodal point") is the center of perspective; moving the camera/lens system around the center of the entrance pupil prevents parallax errors.

While largely irrelevant for live action, this measurement is important for special effects work.

⁽⁸⁾ **Angle of View H, V (Super 35 Cinemascope)**

Horizontal (H) and vertical (V) angles of view for a Super 35 Cinemascope camera aperture (dimensions 22.5 mm x 18.7 mm / 0.8858" x 0.7362").

⁽⁹⁾ **Image Diameter**

The image diameter (ID) is the diameter of the image circle needed for the respective format. These lenses are designed for the largest ID given here.

All data subject to change without notice.