

FA-9500

Quick Setup Guide

10th Edition - Rev.3

Packing list: FA-9500 (1), Quick Setup Guide (1) CD (including Operation Manuals), AC cord (1), AC cord retaining clip (1 set), Rack mount bracket set (1 set)
 Option items: FA-95RU, FA-95PS (with AC cord, AC cord retaining clip (1 set), FA-10DCCRU (Items installed into option slot A/B) FA-95DACBL, FA-95D-D, FA-95DE-E, FA-95AIO (with PC-3307-1 cable), FA-95ALA
 Software option: FA-95CO



1. Rear Connectors

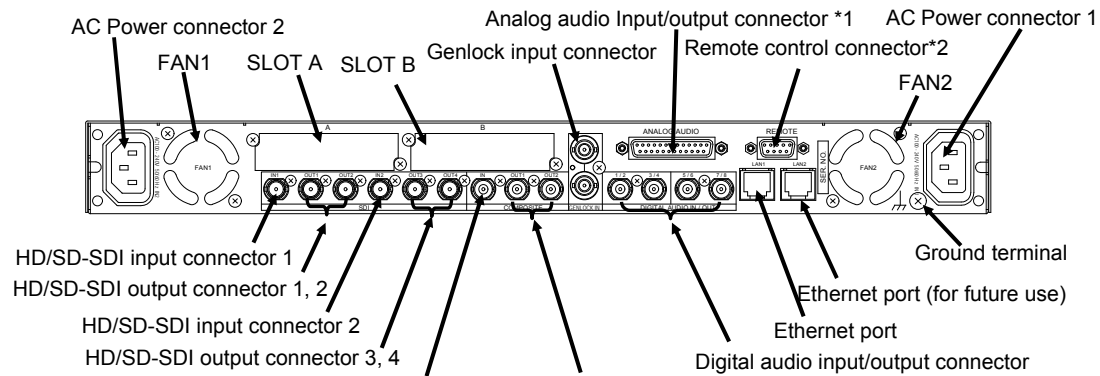

*1 Refer to the Operation Manual section 12. "Analog Audio Connection" for details on the Analog audio connector.
 *2 Refer to the Operation Manual section 14. "REMOTE" for details on the Remote control connector.

◆ FA-95DACBL option

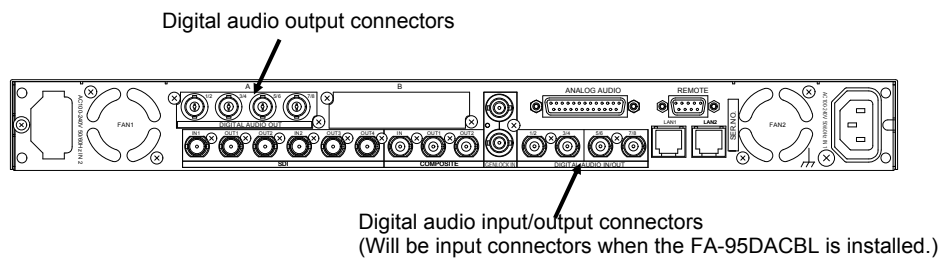

◆ FA-95D-D/DE-E option



◆ FA-95AIO option

Analog component input/output connector (use with the supplied PC-3307-1 cable.) Refer to sec. 16. FA-95AIO Option for details on connectors.

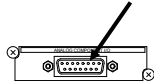

2. Installing the AC Cord Retaining Clip

After connecting the AC cord, secure the AC cord with the supplied ladder strap/retaining clip assembly to prevent accidental removal from the FA-9500. Be sure to install the AC cord retaining clip before mounting the unit into a rack.

- 1) Wrap the retaining clip around the AC cord. (with the anchor of the ladder strap toward the unit.)
- 2) Insert the anchor into the hole next to the AC IN socket.
- 3) Lightly fasten the clip around the AC cord.
- 4) Plug in the power cord.
- 5) Slide the clip on the ladder strap toward the plug.
- 6) Fasten the clip tightly.
- 7) Gently pull on the AC cord to ensure it is secured.

3. Front Operation Panel

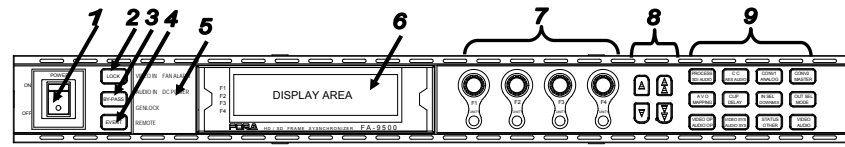

1	POWER switch	Pressing the " " side turns on the power.					
2	LOCK button	Press and hold down to lock the front panel operation. Press and hold down again to unlock.					
3	BY-PASS button	Bypasses input signals (video and audio). The input signals are directly output when the BY-PASS button is pressed (lit).					
4	EVENT button	Used to save and load events.					
5	Status indicator	VIDEO IN	green	Input signal present in the selected connector	REMOTE	green	CONTROL SETTING is set to REMOTE
Unlit			No input signal in the selected connector	Unlit		CONTROL SETTING is set to LOCAL	
AUDIO IN		green	An audio signal present	DC POWER	Red	Power failure	
		Unlit	No audio signal		Unlit	Normal power supply	
GENLOCK		green	Genlock signal present	FAN ALARM	Red	Fan failure	
		Unlit	No genlock signal input		Unlit	All fans normal	
6	Menu display	Used to display menus and make operational settings					
7	Controls (F1-F4) UNITY buttons	Used to change operational settings. Turn and select values. The Unity buttons return the settings to the default values.					
8	Arrow buttons	Single-arrow	Used to move between parameters. (lights if accessible)				
		Double-arrow	Used to move between menus. (lights if accessible)				
9	Menu buttons	Used to select menus.					

Make sure that the LOCK button LED on the front panel is unlit before starting an operation. If LOCK button LED is lit orange, all operations on the front panel except the LOCK button are disabled. Press and hold the LOCK button to unlock the operations.

* Complete connections before turning the power of the unit on.

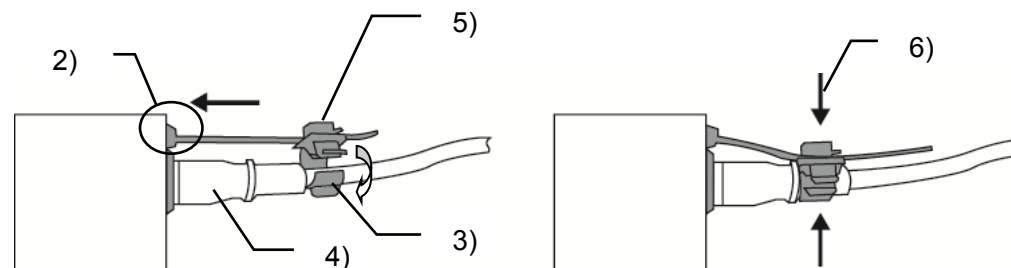

4. Connecting a Computer

◆ Connection using a hub

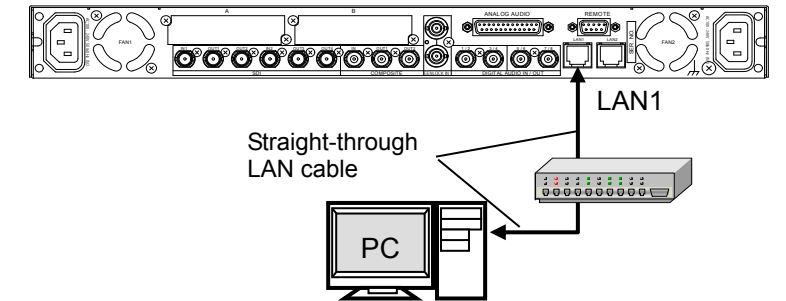

Direct connection using a crossover LAN cable is also possible.

- The FA-9500 network settings must be adjusted for your network after purchase.
- The FA-9500's LAN1 IP address is set to 192.168.0.10 at the factory.
 - Set the IP address and subnet mask of the computer as follows:
 IP address: 192.168.0.1 to 192.168.0.254 (except 192.168.0.10)
 Subnet mask: 255.255.255.0

In Windows, open the **Internet Protocol (TCP/IP) Properties** window. The network settings must be made in the window. See the user's manual of your computer for details.
 See section 9-8 "Network Settings" in the FA-9500 Operation Manual for details on changing the FA-9500's IP address.
 The FA-9500's IP address can be checked in the NETWORK INFO menu (menu page 197). To go to the NETWORK INFO menu, press the STATUS/OTHER button, then a single-arrow button.

5. Connecting via a WEB Browser

Open a web browser on your computer, and enter the address as <http://192.168.0.10/> (factory default setting) in the address bar. Press the [Enter] key to connect to the FA-9500. The login page is displayed.



Click **Login**.
 The authentication dialog appears.

Enter your user name and password. (The default user name and password are set at the factory.)
User name: FA-9500
Password: foranetwork
 See section 9. "Control via WEB Browser" in the FA-9500 Operation Manual for details on Web browser control screens.

6. Menu Display

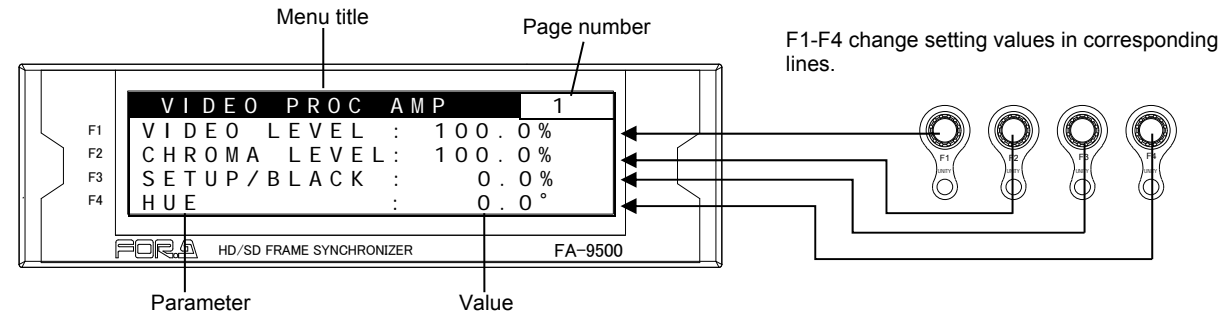

7. Menu List

Menu Button	VIDEO menus (lit green)	AUDIO menus (lit orange)
PROCESS SDI AUDIO	◇VIDEO PROC AMP	◇SDI AUDIO GAIN ● SDI AUDIO CLOCK ● SDI REMAPPING ● SDI MONO SUM ● SDI IN AUDIO
CC AES AUDIO	◇WHITE LEVEL ◇BLACK LEVEL	GAMMA LEVEL COLOR CORRECT ◇AES IN GAIN ● AES HYSTERESIS ● AES REMAPPING AES MONO SUM ● AES I/O SETUP *1
CONV1 ANALOG	◇● CONV1 U/D MODE ◇CONV1 SIZE/POS ◇CONV1 CROPPING	CONV1 IMPROVE CONV1 SIDE RGB ◇ANALOG IN LEVEL ANALOG IN GAIN ANALOG OUT LEVEL ANALOG OUT GAIN ● ANALOG REMAPPING ● ANALOG MONO SUM ● ANALOG SYSTEM
CONV2 MASTER	◇● CONV2 U/D MODE ◇CONV2 SIZE/POS ◇CONV2 CROPPING	CONV2 IMPROVE CONV2 SIDE RGB ◇MASTER OUT GAIN
AVO *1 MAPPING	◇● AVO SETTING ◇USER1-5 LEVEL SET	USER1-2 AREA SET AVO SETUP *1 ◇● SOURCE/SRC SEL
CLIP DELAY	◇YCbPr/RGB CLIP	COMPOSITE CLIP ◇AUDIO DELAY
IN SEL DOWN MIX	◇● VIDEO INPUT SET ● SD INPUT ASPECT CHGOV(CHANGEOVER) MODE SET *2 SDI ERROR TRG *2 FORMAT ERROR TRG *2 CRC ERROR TRG *2 BLACK VIDEO TRG *2 AUDIO LOSS TRG *2	AUDIO ERR TRG *2 SILENCE TRG *2 CHGOV STATUS *2 CHGOV VID STATUS *2 CHGOV AUD STATUS *2 AUD LOSS STATUS *2 AUD ERROR STATUS *2 SILENCE STATUS *2 ◇● DOWN MIX SET ● DOWN MIX ASSIGN
OUT SEL MODE	◇● VIDEO OUT MODE ◇● SD11/2 OUT SET ● SDI3/4 OUT SET	● COMPOSITE SET ● COMPONENT SET *5 ◇● AUDIO MODE SET
VIDEO OP AUDIO OP	◇CONV1 LOGO SEL ◇CONV1 KEYSER SET	CONV2 LOGO SEL CONV2 KEYSER SET ◇● Dolby AUX OUT *3 ● Dolby DEC INPUT *3 ● Dolby DEC REF *3 ● Dolby DOWNMIX *3 ◇Dolby DEC GAIN *3 ● Dolby ENC INPUT *4 ● Dolby ENC SET *4 ● METADATA INPUT *4 ◇LOUD MEASURE 1, 2 *6 LOUD CTRL ENA1, 2 *6 LOUD CTRL SET1, 2 *6 LOUD CH ASGN1, 2 *6 ◇LOUD STANDARD *6
VIDEO SYS AUDIO SYS	◇● FS MODE SET FREEZE SET COMPOSITE SET ● VIDEO SUB ● TEST SIGNAL HD PHASE SET SD PHASE SET VIDEO POSITION ● CONV1 ANC SET ● CONV2 ANC SET CONV1 AUDIO GRP	CONV2 AUDIO GRP SD LINE MASK ANC DETECT LINE ANC DETECT SEL ANC DATA EMBED ANC EMBED LINE ANC LOSS SET WSS AFD ERROR NTSC SETUP *5 ● PAL-M MODE SET ◇● FADE IN/OUT ● DIGITAL AUDIO ● AUDIO ERR SENSE ● DIGITAL SILENCE
STATUS OTHER	◇ UNIT ALARM ◇VIDEO IN STATUS COMPONENT INPUT *5 ◇VIDEO OUT STATUS COMPONENT OUTPUT *5 ◇SOURCE AUDIO CH1 - 16 ◇SDI1 IN AUDIO CH1 - 16 ◇SDI2 IN AUDIO CH1 - 16 ◇AES IN AUDIO CH1 - 8 ◇ANALOG IN AUDIO CH1 - 4 ◇SDI1/2 OUT AUDIO CH1 - 16 ◇SDI3/4 OUT AUDIO CH1 - 16 ◇AES OUT AUDIO CH1 - 8 ◇ANALOG OUT AUDIO CH1 - 4	◇Dolby AUX STATUS *3 ◇AFD IN STATUS ANC IN STATUS ANC IN STATUS1-2 ◇CONV1 ANC OUT CONV1 S2016 OUT CONV1 VI OUT CONV1 WSS OUT CONV1 ANC OUT1 ◇CONV2 ANC OUT CONV2 S2016 OUT CONV2 VI OUT CONV2 WSS OUT CONV2 ANC OUT1 ◇● CONTROL SETTING FRONT OPERATION FRONT PANEL SET GPI SETTING NETWORK INFO UNIT Ver. OPTION A Ver. OPTION B Ver. OTHER OPTION SOFT OPTION1 SOFT OPTION2
VIDEO AUDIO	VIDEO menus	AUDIO menus

8. Menu Operation

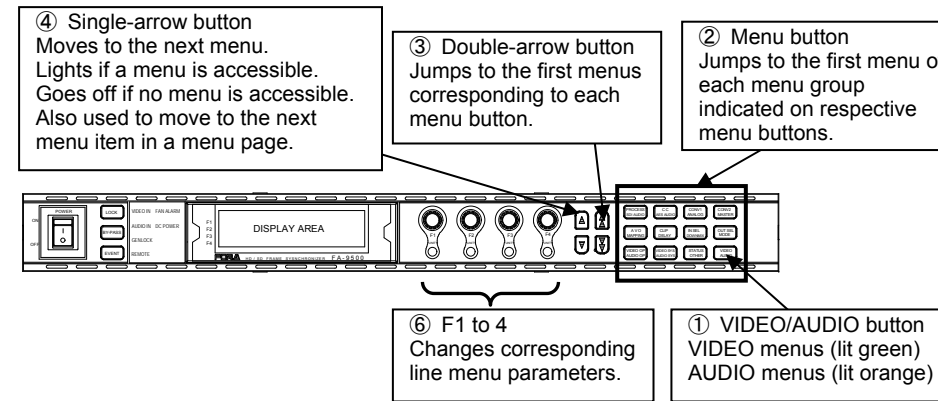

- Select VIDEO or AUDIO by the VIDEO /AUDIO button. Every press of the VIDEO/AUDIO button alternates the menu button assignments between video and audio menus. The button indicators light green when the buttons are accessible to video menus that are indicated on the top row of each menu button. They light orange when they are accessible to audio menus that are indicated on the bottom row of each menu button.
- Press a menu button to select a menu group that includes the desired menu.
- ④ Move to the desired menu using double-arrow and/or single-arrow buttons. The single-arrow buttons allow you to move between menus if the selected menu button has multiple menu pages in the category. The single-arrow button lights up when there are more menus to be accessed in the direction. If the single-arrow button is unlit, the direction is not accessible. The double-arrow buttons allow you to go to menus indicated with ◇ in the menu list.
- F1 to F4 control knobs allow you to change the value of respective lines. Turn the operative control knob of an LED that is lit to change the value.

<Comments on the menu list>

- ◇ Can be navigated to using double (up and down) arrow buttons. "◇" is not shown in the menu display.
- When settings in menus shown with a black circle (●) are changed in LIVE SAFE mode, single (up and down) arrow buttons and the LED around the control knob of which setting is changed blink confirming the setting change. To set the FA-9520 to LIVE SAFE mode, change the mode setting referring to section 7-3. "FRONT OPERATION".

*1 Hidden if the optional FA-95DACBL is installed.

*2 Shown if the optional FA-95CO is installed.

*3 Shown if the optional FA-95D-D is installed.

*4 Shown if the optional FA-95DE-E is installed.

*5 Shown if the optional FA-95AIO is installed.

*6 Shown if the optional FA-95ALA is installed.

9. Resetting to Default

The UNITY indicator light goes off when the setting value is changed from the default value. Pressing the UNITY button while the light is off returns the corresponding setting value to the default value. Then the light goes off. Pressing the button again returns the value to the previous value before resetting to the default value.

* The above procedure is in NORMAL mode. Normally the unit starts up in NORMAL mode. There is another mode called **LIVE SAFE** mode, in which some menus request a setting change confirmation to protect important settings from accidental changes. If the unit is in LIVE SAFE mode, see sec. 4-2-7. "Resetting to Default" in the FA-9500 Operation Manual.

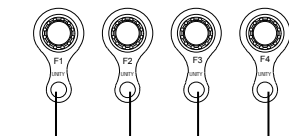

Press the UNITY button to reset the value. The indicator lights up orange.

Precautions

- Operate the unit **only** at the specified supply voltage.
- Ensure** the unit is properly grounded at all times.
- Ensure** the power cord and connectors are firmly connected.
- Do not** access circuitry with power applied to the unit.
- Unit **should not** be operated or stored with the cover, panels, and/or casing removed.
- Unit **should not** be operated or stored in a humid, dusty, etc. environment. Doing so could result in fire or electrical shock.
- Do not** allow fluids, metal fragments, or any other foreign objects to enter the unit. If foreign matter does enter the unit, turn the power off and disconnect the power cord immediately. Remove the material or contact your authorized service representative
- If you notice any strange smells or noises coming from the unit, turn the power off immediately, turn OFF the power switch, disconnect the power cord, then contact your authorized service representative.